

FAG HYDNUT95-INCH参数

尺寸	d_{2G}	94.742	mm	-
	D_m	165	mm	-
	b_1	40	mm	-
说明		93.368	mm	节圆直径
		93.3679	mm	节圆直径
		5	mm	行程
尺寸	D_K	136	mm	-
	d_K	96	mm	-
	g	3	mm	-
重量	m	4300	g	质量, 液压螺母
说明		52	cm	活塞面积
		416	kN	压紧力 800bar
		12		每英寸的螺纹数

FAG HYDNUT95-INCH图片

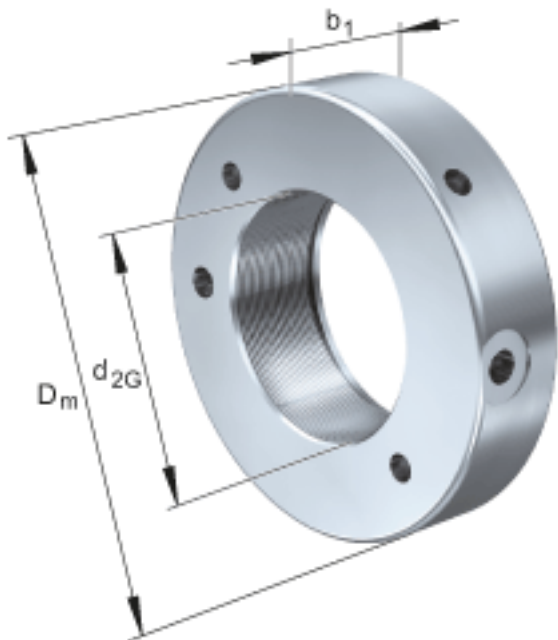

参考资料:<http://www.sozhou.com/p/07f8b163.html>

