

SKF 81272 M参数

主要尺寸	d	360	mm	-
	D	500	mm	-
	H	110	mm	-
基本额定载荷	C	2160000	N	动载荷
	C_0	10400000	N	静载荷
疲劳载荷极限	P_u	750000	N	-
最小载荷系数	A	8.7	-	-
额定转速	额定转度	260	r/min	-
	极限转速	530	r/min	-
重量	重量	65500	g	-
型号	完整轴承	81272 M	-	-
	滚子和保持架推力组件	K 81272 M	-	-

SKF 81272 M图片

完整轴承

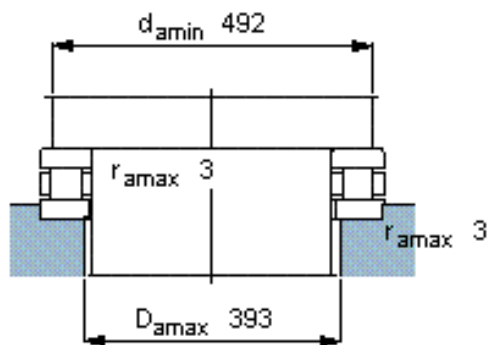
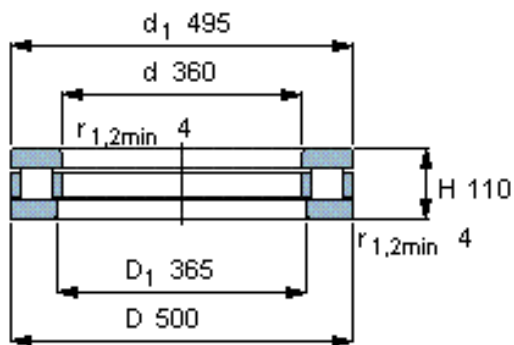

滚子和保持架推力组件

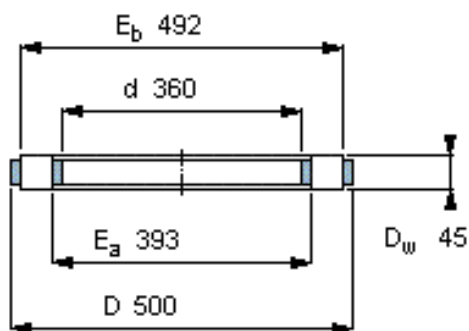

适宜的部件

轴垫圈
WS 81272

轴承座垫圈
GS 81272

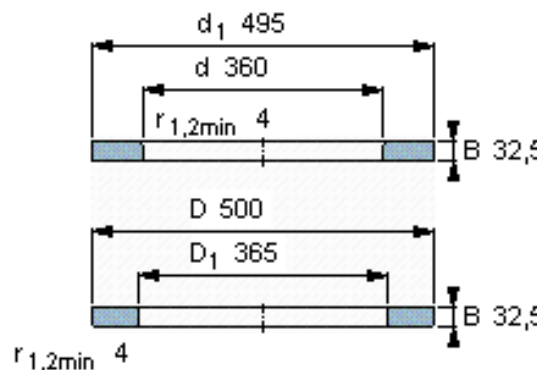

K 81272 M

质量 kg 18,5

完整轴承

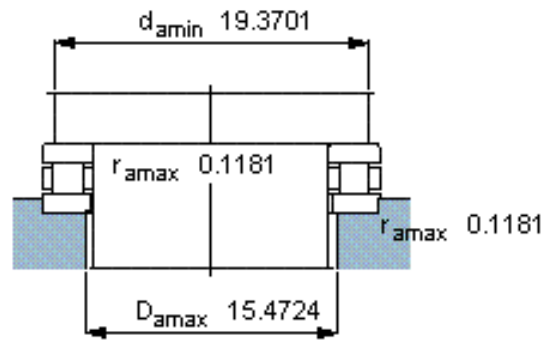
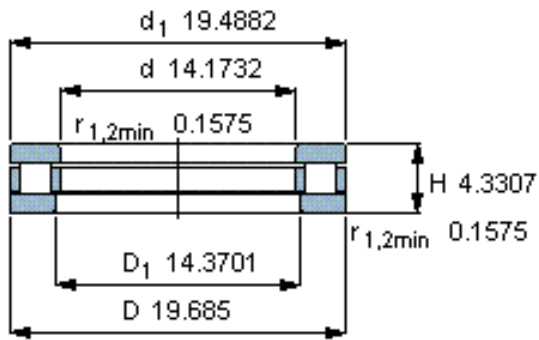

滚子和保持架推力组件

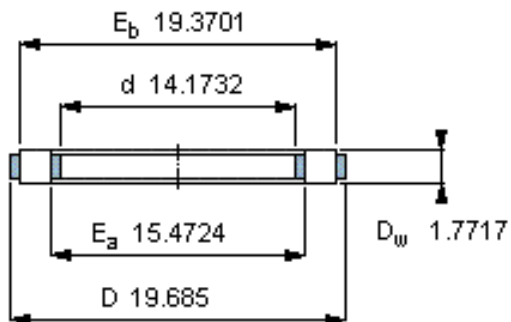

K 81272 M

质量 kg 18,5

适宜的部件

轴垫圈
WS 81272

轴承座垫圈
GS 81272

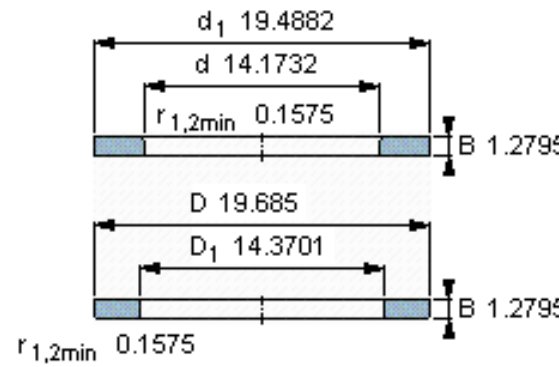

参考资料: <http://www.sozhou.com/p/36821774.html>