

SKF BEAS 012042-2RS参数

主要尺寸	d	12	mm	-
	D	42	mm	-
	H	25	mm	-
基本额定载荷	C	16800	N	动载荷
	C_0	24500	N	静载荷
疲劳载荷极限	P_u	915	N	-
可达转速	Attainable speed	4000	r/min	-
重量	重量	200	g	-
型号	型号	BEAS 012042-2RS	-	-

SKF BEAS 012042-2RS图片

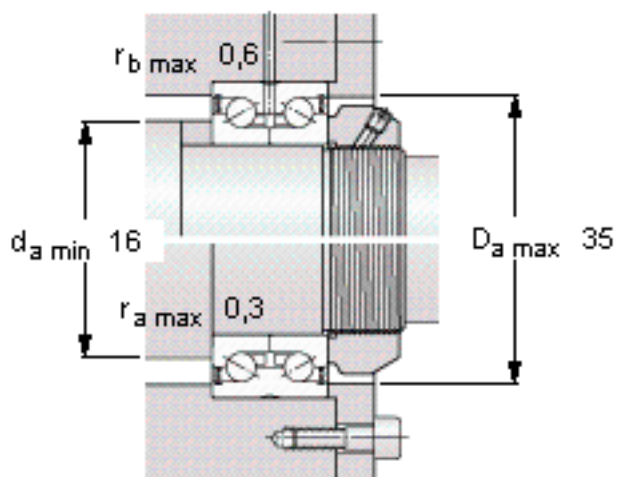
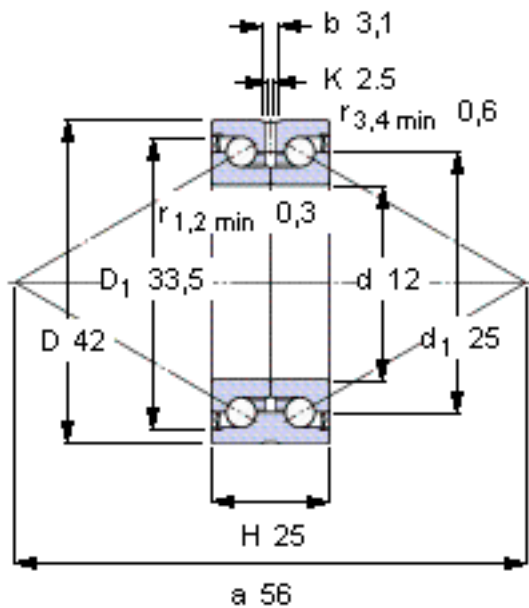

Preload¹⁾ [N]

600

Frictional moment¹⁾ [Nm]

(guideline value)

0,16

¹⁾ Values apply to unmounted bearings

Static stiffness¹⁾

(guideline values)

Axial [N/ μm]

350

Moment [Nm/mrad]

80

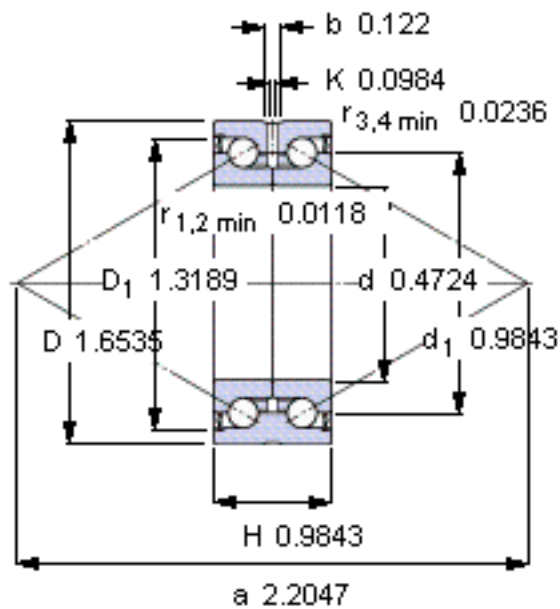

Preload¹⁾ [N]

600

Frictional moment¹⁾ [Nm]

(guideline value)

0,16

¹⁾ Values apply to unmounted bearings

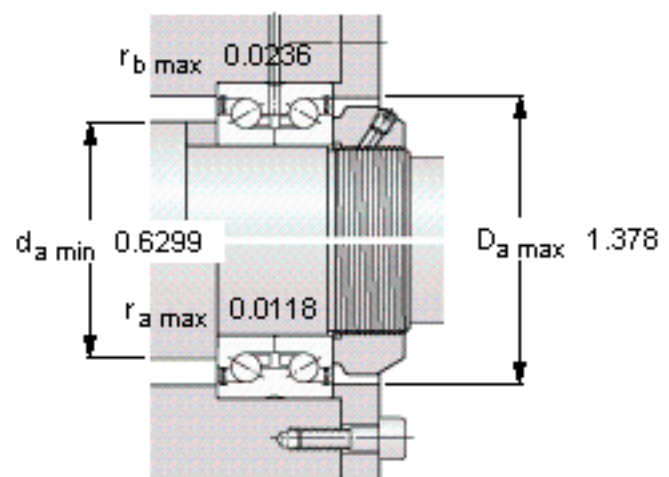

Static stiffness¹⁾

(guideline values)

Axial [N/ μm] 350

Moment [Nm/mrad] 80