

SKF S7013 CD/HCP4A参数

主要尺寸	d	65	mm	-
	D	100	mm	-
	B	18	mm	-
基本额定载荷	C	41600	N	动载荷
	C_0	37500	N	静载荷
疲劳载荷极限	P_u	1600	N	-
可达转速	Grease	16000	r/min	-
	Oil-air	-	r/min	-
重量	重量	370	g	-
型号	型号	S7013 CD/HCP4A	-	-

SKF S7013 CD/HCP4A图片

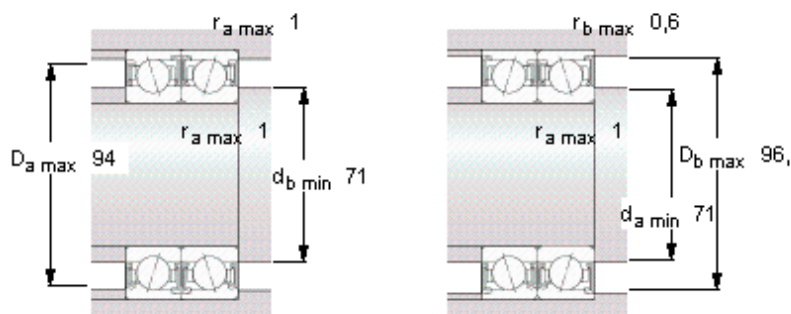
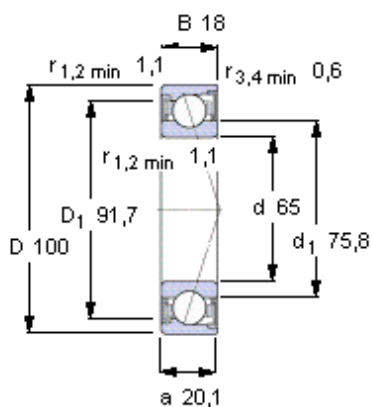

Ball diameter 11,112

Number of balls 20

未安装时的预载荷 [N]

背对背配置，面对面配置

预载荷等级

A	B	C	D
160	320	640	1280

Static axial stiffness [N/μm]

(guideline value)

预载荷等级

A	B	C	D
82	112	158	230

Reference grease quantity [cm³]

G_{ref} -

计算系数

for equivalent bearing load

f_0 15,8

for preload in mounted bearing sets

f 1,13

f_1 1

f_{2A} 1

f_{2B} 1,02

f_{2C} 1,05

f_{2D} 1,09

f_{HC} 1,02

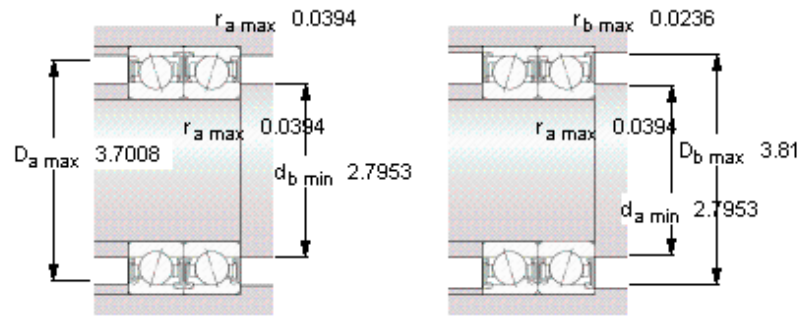
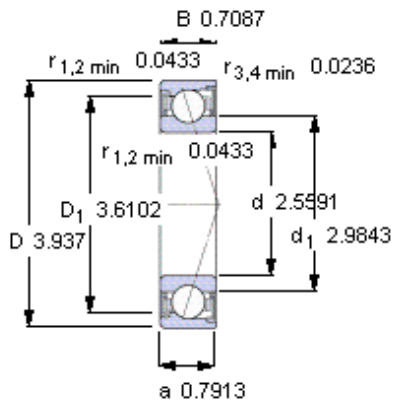

Ball diameter 11,112

Number of balls 20

未安装时的预载荷 [N]

背对背配置，面对面配置

预载荷等级

A	B	C	D
160	320	640	1280

Static axial stiffness [N/μm]

(guideline value)

预载荷等级

A	B	C	D
82	112	158	230

Reference grease quantity [cm³]

G_{ref} -

计算系数

for equivalent bearing load

f₀ 15,6

for preload in mounted bearing sets

f 1,13

f₁ 1

f_{2A} 1

f_{2B} 1,02

f_{2C} 1,05

f_{2D} 1,09

f_{HC} 1,02