

KOYO 7913CDB FY参数

主要尺寸	SD	65	mm	内径
	D	90	mm	外径
	B	26	mm	宽度
	R	1.0	mm	(最小)
型号	ORDER	7913CDB FY		型号
基本额定载荷	C	33700	N	动载荷
	C0	42300	N	静载荷
极限转速	NG	8600	1/min	脂润滑
	NO	12000	1/min	油润滑

KOYO 7913CDB FY图片

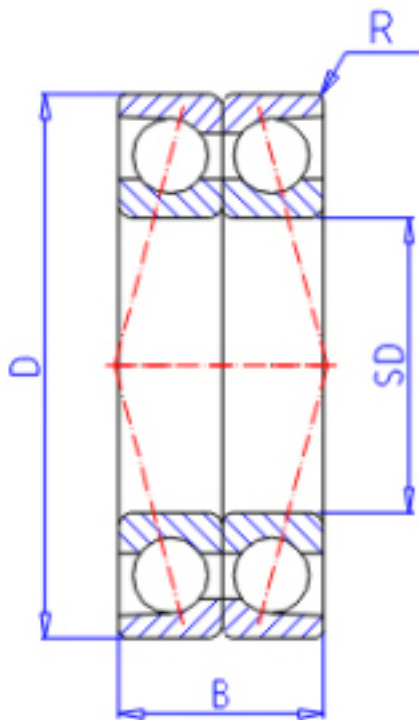

参考资料:<http://www.sozhou.com/p/5669f546.html>

