

SKF 7024 CD/HCP4AL 参数

主要尺寸	d	120	mm	-
	D	180	mm	-
	B	28	mm	-
基本额定载荷	C	114000	N	动载荷
	C_0	122000	N	静载荷
疲劳载荷极限	P_u	4250	N	-
可达转速	Grease	8500	r/min	-
	Oil-air	13000	r/min	-
重量	重量	1750	g	-
型号	型号	7024 CD/HCP4AL	-	-

SKF 7024 CD/HCP4AL 图片

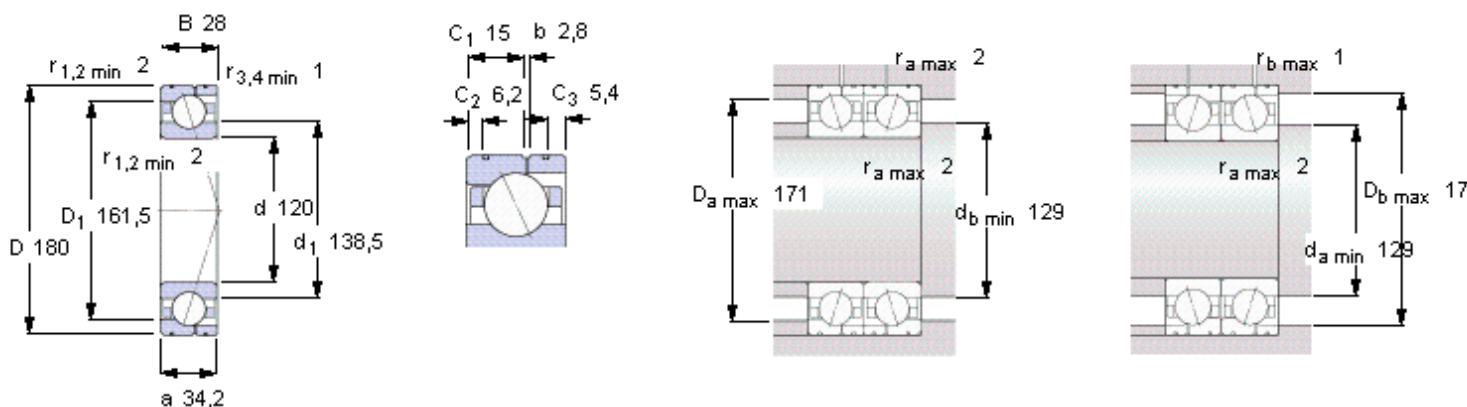

Ball diameter 19,05

Number of balls 22

未安装时的预载荷 [N]

背对背配置，面对面配置

预载荷等级

A	B	C	D
430	860	1720	3440

Static axial stiffness [N/ μm]

(guideline value)

预载荷等级

A	B	C	D
146	198	278	404

Reference grease quantity [cm³]

G_{ref} 27

计算系数

for equivalent bearing load

f_0 15,7

for preload in mounted bearing sets

f 1,17

f_1 1

f_{2A} 1

f_{2B} 1,02

f_{2C} 1,05

f_{2D} 1,09

f_{HC} 1,02

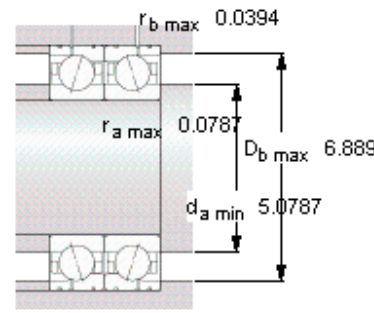
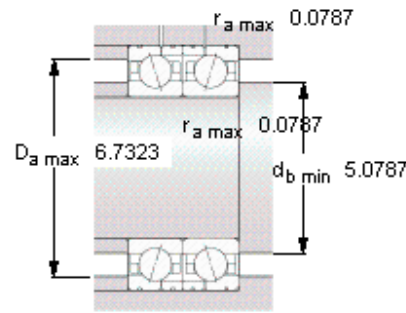
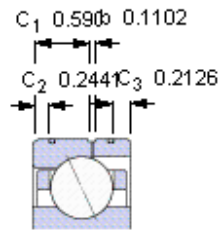
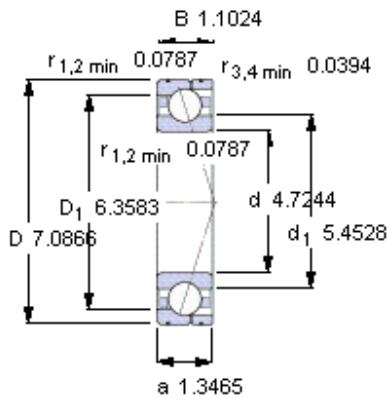

Ball diameter 19,05

Number of balls 22

未安装时的预载荷 [N]

背对背配置，面对面配置

预载荷等级

A	B	C	D
430	860	1720	3440

Static axial stiffness [N/μm]

(guideline value)

预载荷等级

A	B	C	D
146	198	278	404

Reference grease quantity [cm³]

G_{ref} 27

计算系数

for equivalent bearing load

f₀ 15,7

for preload in mounted bearing sets

f 1,17

f₁ 1

f_{2A} 1

f_{2B} 1,02

f_{2C} 1,05

f_{2D} 1,09

f_{HC} 1,02