

SKF 7226 CD/HCP4A参数

主要尺寸	d	130	mm	-
	D	230	mm	-
	B	40	mm	-
基本额定载荷	C	216000	N	动载荷
	C_0	224000	N	静载荷
疲劳载荷极限	P_u	6950	N	-
可达转速	Grease	7500	r/min	-
	Oil-air	11000	r/min	-
重量	重量	5200	g	-
型号	型号	7226 CD/HCP4A	-	-

SKF 7226 CD/HCP4A图片

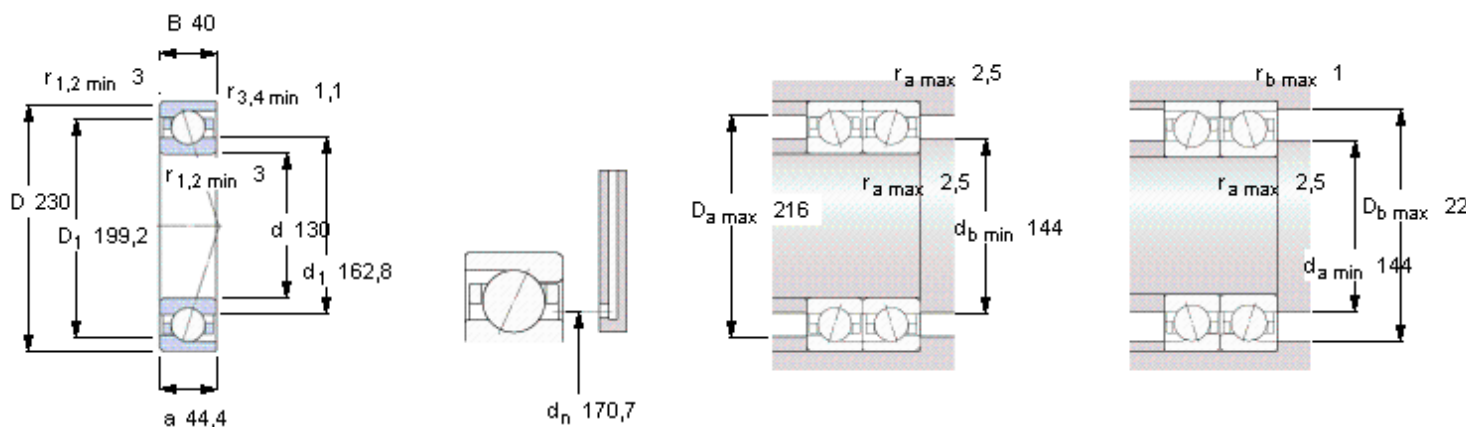

Ball diameter 30,162

Number of balls 17

未安装时的预载荷 [N]

背对背配置，面对面配置

预载荷等级

A	B	C	D
810	1620	3240	6480

Static axial stiffness [N/μm]

(guideline value)

预载荷等级

A	B	C	D
172	232	323	461

Reference grease quantity [cm³]

G_{ref} 72

计算系数

for equivalent bearing load

f_0 14,9

for preload in mounted bearing sets

f 1,09

f_1 1

f_{2A} 1

f_{2B} 1,01

f_{2C} 1,03

f_{2D} 1,06

f_{HC} 1,01

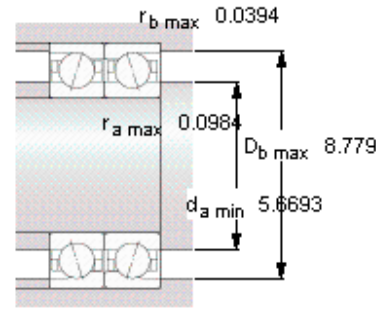
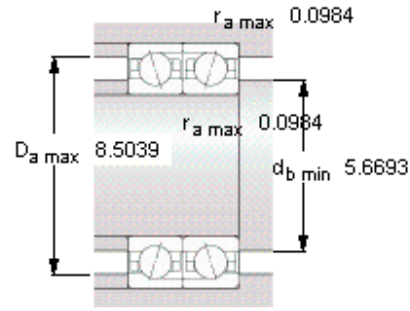
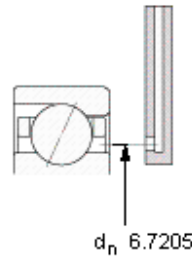
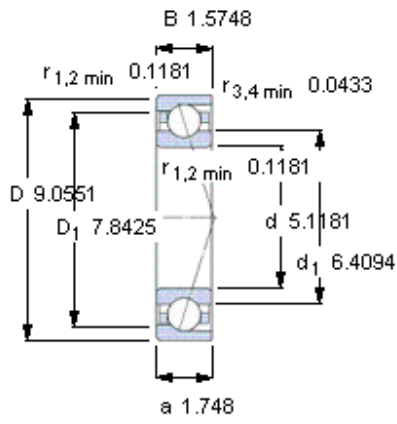

Ball diameter 30,162

Number of balls 17

未安装时的预载荷 [N]

背对背配置，面对面配置

预载荷等级

A	B	C	D
810	1620	3240	6480

Static axial stiffness [N/μm]

(guideline value)

预载荷等级

A	B	C	D
172	232	323	461

Reference grease quantity [cm³]

G_{ref} 72

计算系数

for equivalent bearing load

f₀ 14,9

for preload in mounted bearing sets

f 1,09

f₁ 1

f_{2A} 1

f_{2B} 1,01

f_{2C} 1,03

f_{2D} 1,06

f_{HC} 1,01