

### SKF 53205参数

主要尺寸	d	25	mm	-
	D	47	mm	-
	H <sub>1</sub>	19	mm	-
基本额定载荷	C	27600	N	动载荷
	C <sub>0</sub>	55000	N	静载荷
疲劳载荷极限	P <sub>u</sub>	2040	N	-
最小载荷系数	A	0.015	-	-
额定转速	额定转度	5300	r/min	-
	极限转速	7500	r/min	-
重量	轴承+垫圈	150	g	-
型号	轴承	53205	-	-
	座圈	U 205	-	-

### SKF 53205图片

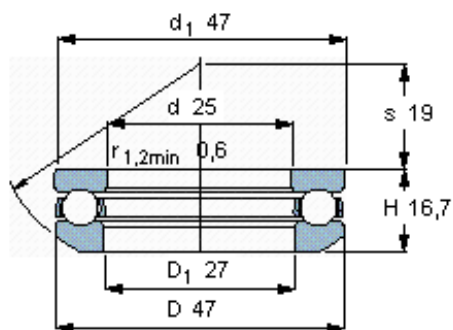

垫圈的球面曲率半径

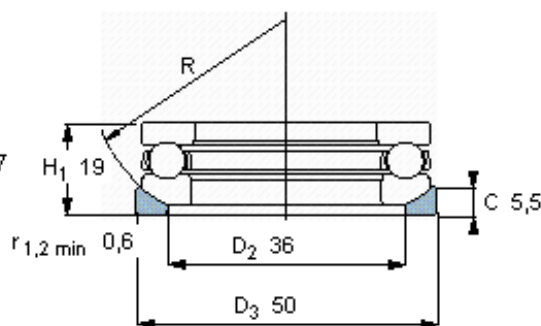

R 40

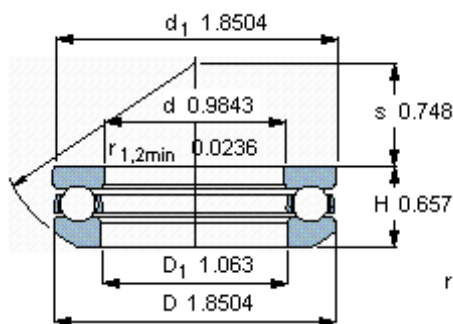
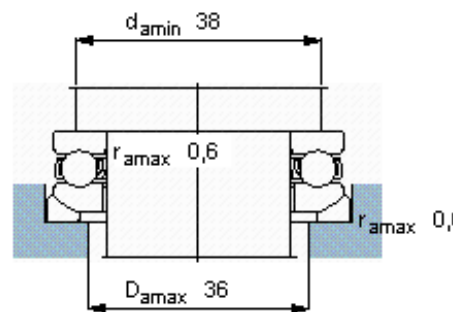

垫圈的球面曲率半径

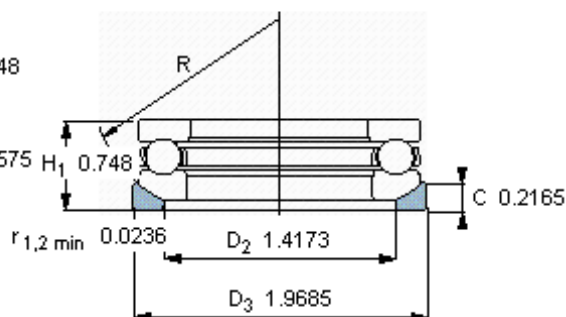

R 1.5748

