

SKF 71960 CDMA/P4A参数

主要尺寸	d	300	mm	-
	D	420	mm	-
	B	56	mm	-
基本额定载荷	C	371000	N	动载荷
	C_0	600000	N	静载荷
疲劳载荷极限	P_u	13400	N	-
可达转速	Grease	3000	r/min	-
	Oil-air	4500	r/min	-
重量	重量	23000	g	-
型号	型号	71960 CDMA/P4A	-	-

SKF 71960 CDMA/P4A图片

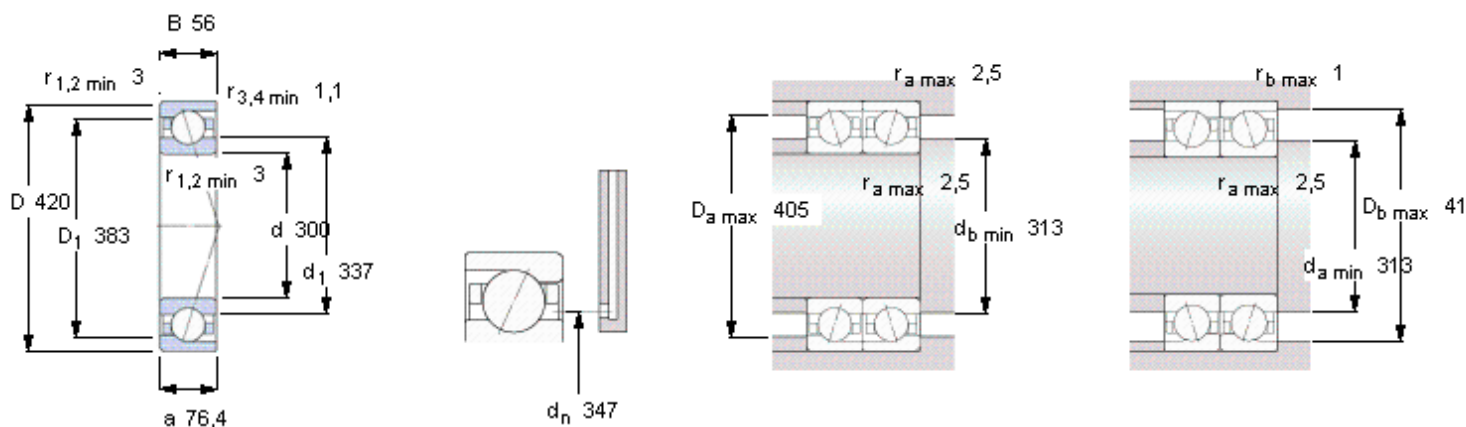

Ball diameter 38,1

Number of balls 26

未安装时的预载荷 [N]

背对背配置，面对面配置

预载荷等级

A	B	C	D
1400	2800	5600	11200

Static axial stiffness [N/ μ m]

(guideline value)

预载荷等级

A	B	C	D
272	369	514	741

Reference grease quantity [cm³]

G_{ref} 265

计算系数

for equivalent bearing load

f_0 16,3

for preload in mounted bearing sets

f 1,22

f_1 1

f_{2A} 1

f_{2B} 1,04

f_{2C} 1,09

f_{2D} 1,15

f_{HC} 1

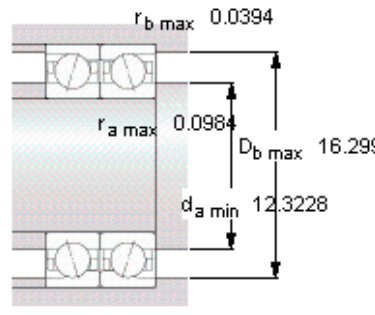
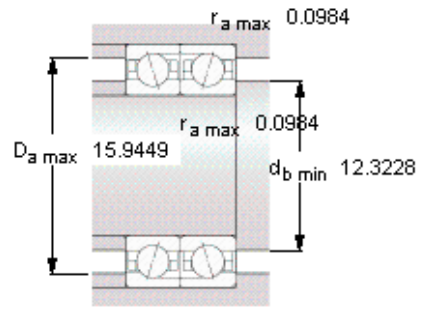
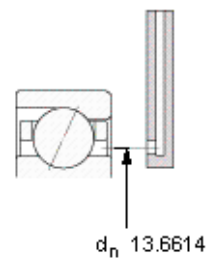
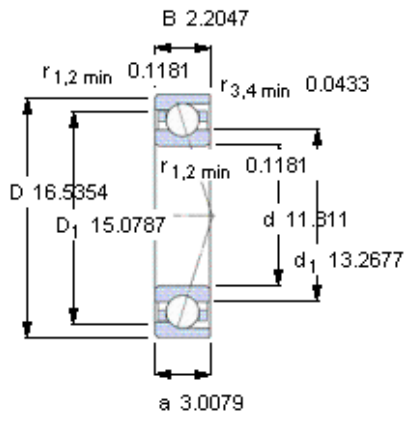

Ball diameter 38,1
Number of balls 26

未安装时的预载荷 [N]
 背对背配置，面对面配置
 预载荷等级

A	B	C	D
1400	2800	5600	11200

Static axial stiffness [N/μm]
 (guideline value)

预载荷等级

A	B	C	D
272	369	514	741

Reference grease quantity [cm³]
 G_{ref} 265

计算系数
for equivalent bearing load
 f₀ 16,3

for preload in mounted bearing sets
 f 1,22
 f₁ 1
 f_{2A} 1
 f_{2B} 1,04
 f_{2C} 1,09
 f_{2D} 1,15
 f_{HC} 1