

SKF 7007 CD/P4A参数

主要尺寸	d	35	mm	-
	D	62	mm	-
	B	14	mm	-
基本额定载荷	C	15600	N	动载荷
	C_0	9500	N	静载荷
疲劳载荷极限	P_u	400	N	-
可达转速	Grease	24000	r/min	-
	Oil-air	36000	r/min	-
重量	重量	150	g	-
型号	型号	7007 CD/P4A	-	-

SKF 7007 CD/P4A图片

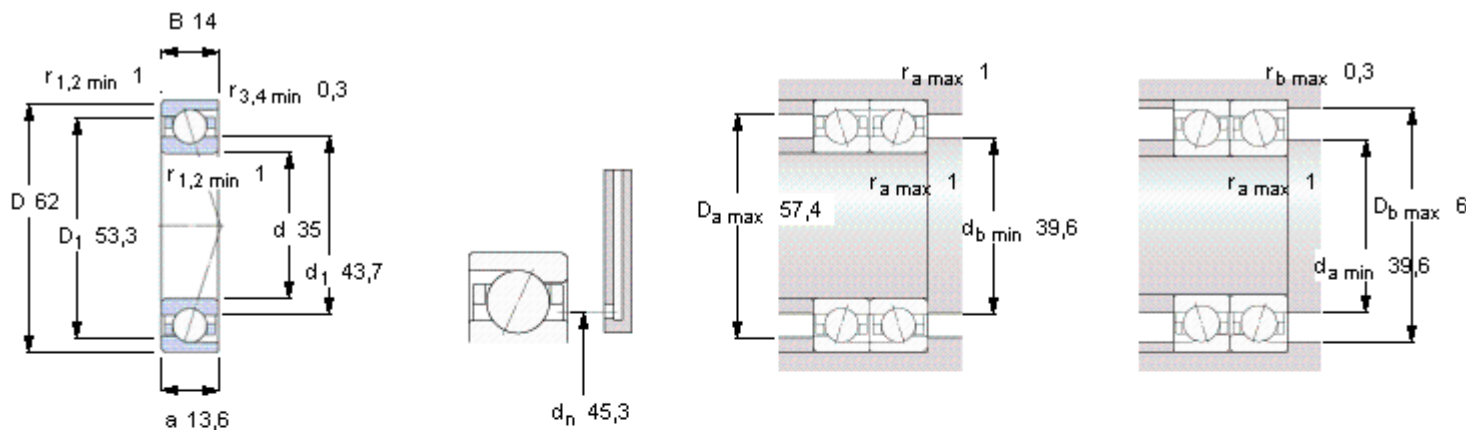

Ball diameter 7,938

Number of balls 16

未安装时的预载荷 [N]

背对背配置，面对面配置

预载荷等级

A	B	C	D
60	120	240	480

Static axial stiffness [N/ μm]

(guideline value)

预载荷等级

A	B	C	D
36	47	64	90

Reference grease quantity [cm³]

G_{ref} 2

计算系数

for equivalent bearing load

f_0 9,7

for preload in mounted bearing sets

f 1,06

f_1 1

f_{2A} 1

f_{2B} 1,02

f_{2C} 1,05

f_{2D} 1,09

f_{HC} 1

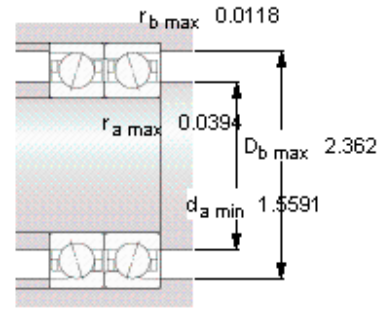
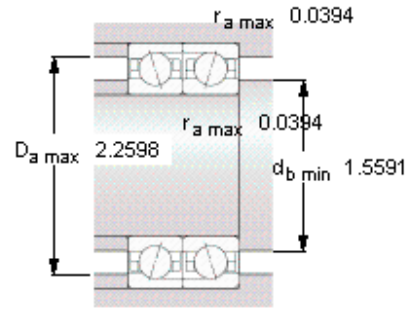
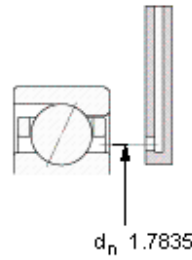
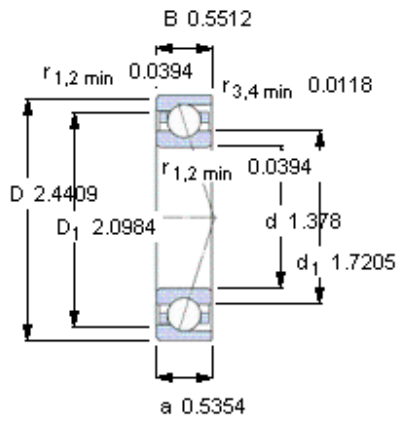

Ball diameter 7,938

Number of balls 16

未安装时的预载荷 [N]

背对背配置，面对面配置

预载荷等级

A	B	C	D
60	120	240	480

Static axial stiffness [N/μm]

(guideline value)

预载荷等级

A	B	C	D
36	47	64	90

Reference grease quantity [cm³]

G_{ref} 2

计算系数

for equivalent bearing load

f₀ 9,7

for preload in mounted bearing sets

f 1,06

f₁ 1

f_{2A} 1

f_{2B} 1,02

f_{2C} 1,05

f_{2D} 1,09

f_{HC} 1