

### SKF 81268 M参数

主要尺寸	d	340	mm	-
	D	460	mm	-
	H	96	mm	-
基本额定载荷	C	1630000	N	动载荷
	$C_0$	8000000	N	静载荷
疲劳载荷极限	$P_u$	585000	N	-
最小载荷系数	A	5.1	-	-
额定转速	额定转度	300	r/min	-
	极限转速	600	r/min	-
重量	重量	47000	g	-
型号	完整轴承	81268 M	-	-
	滚子和保持架推力组件	K 81268 M	-	-

### SKF 81268 M图片

#### 完整轴承

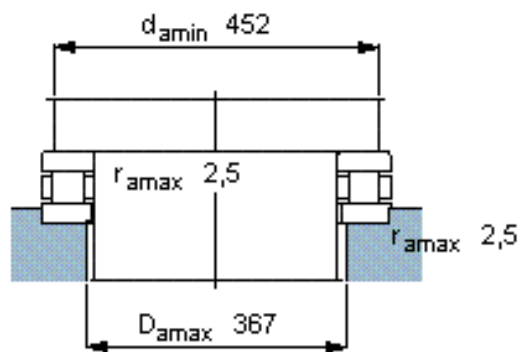
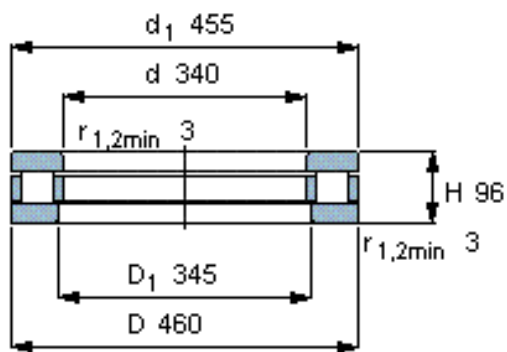

#### 滚子和保持架推力组件

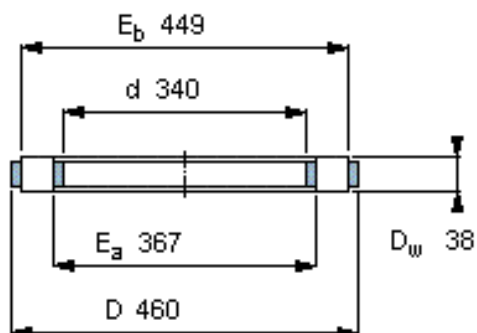

#### 适宜的部件

轴垫圈  
WS 81268

轴承座垫圈  
GS 81268

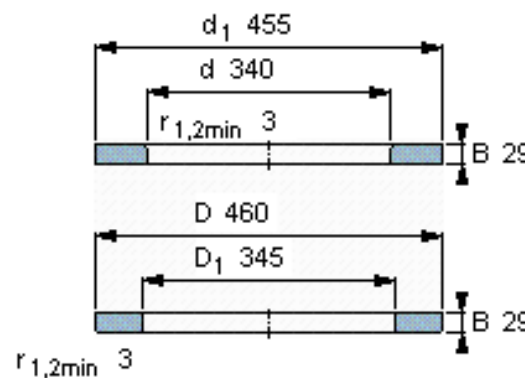

K 81268 M

质量 kg 13,7

**完整轴承**

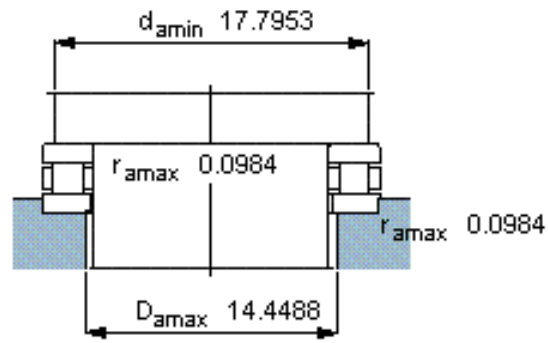
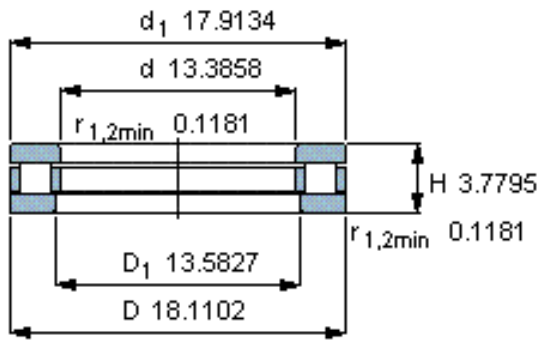

**滚子和保持架推力组件**

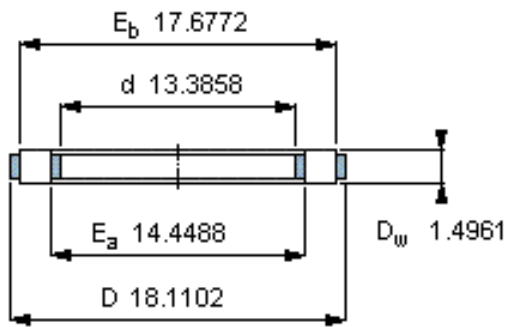

K 81268 M

质量 kg 13,7

**适宜的部件**

轴垫圈  
WS 81268

轴承座垫圈  
GS 81268

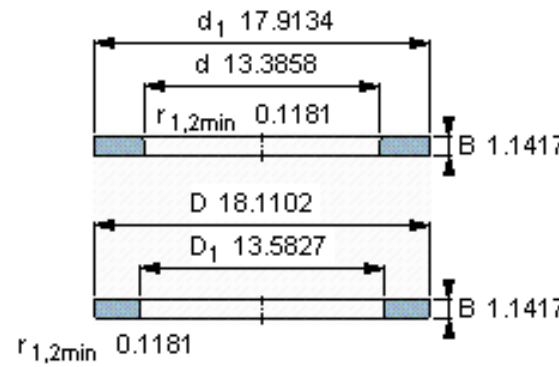

参考资料: <http://www.sozhou.com/p/d25c75ff.html>