

SKF 7224 CD/HCP4A参数

主要尺寸	d	120	mm	-
	D	215	mm	-
	B	40	mm	-
基本额定载荷	C	199000	N	动载荷
	C_0	193000	N	静载荷
疲劳载荷极限	P_u	6300	N	-
可达转速	Grease	8000	r/min	-
	Oil-air	12000	r/min	-
重量	重量	4400	g	-
型号	型号	7224 CD/HCP4A	-	-

SKF 7224 CD/HCP4A图片

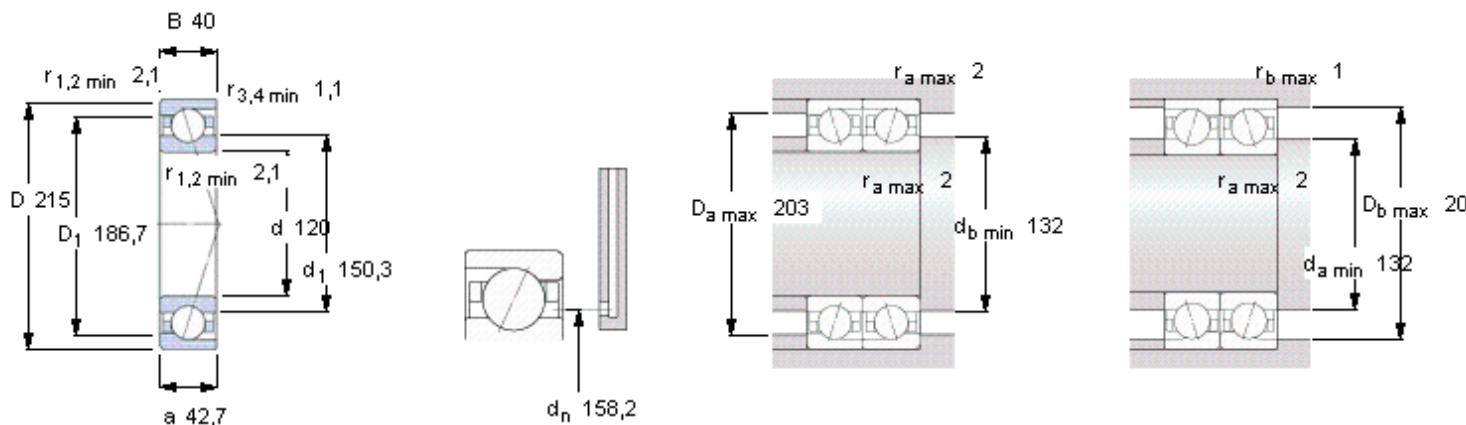

Ball diameter 30,162

Number of balls 15

未安装时的预载荷 [N]

背对背配置，面对面配置

预载荷等级

A	B	C	D
750	1500	3000	6000

Static axial stiffness [N/ μm]

(guideline value)

预载荷等级

A	B	C	D
154	209	289	414

Reference grease quantity [cm³]

G_{ref} 69

计算系数

for equivalent bearing load

f_0 14,6

for preload in mounted bearing sets

f 1,08

f_1 1

f_{2A} 1

f_{2B} 1,01

f_{2C} 1,03

f_{2D} 1,06

f_{HC} 1,01

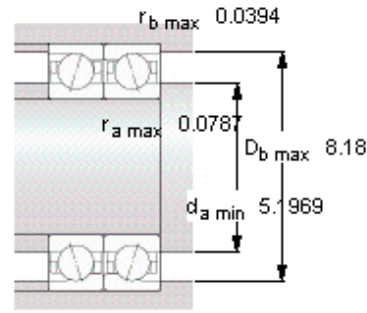
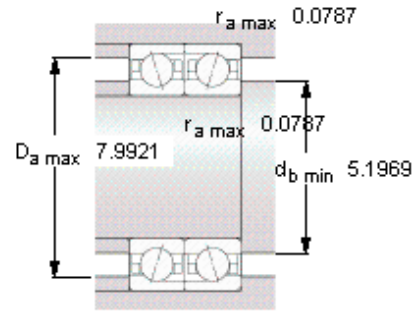
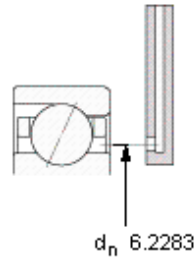
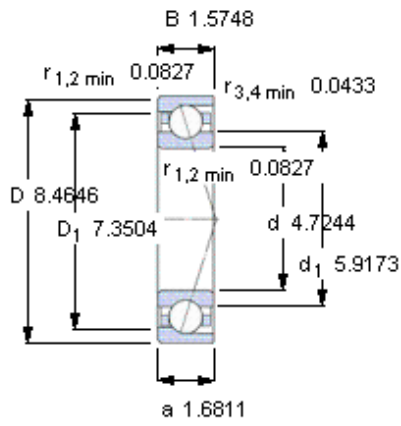

Ball diameter 30,162

Number of balls 15

未安装时的预载荷 [N]

背对背配置，面对面配置

预载荷等级

A	B	C	D
750	1500	3000	6000

Static axial stiffness [N/μm]

(guideline value)

预载荷等级

A	B	C	D
154	209	289	414

Reference grease quantity [cm³]

G_{ref} 69

计算系数

for equivalent bearing load

f₀ 14,6

for preload in mounted bearing sets

f 1,08

f₁ 1

f_{2A} 1

f_{2B} 1,01

f_{2C} 1,03

f_{2D} 1,06

f_{HC} 1,01